

The Harman/Kardon
Model 100+

AM/Stereo FM
Multichannel Receiver

harman/kardon
THE MUSIC COMPANY

Instruction Manual

INTRODUCTION

You are now the owner of an instrument unique in concept and design. The Harman/Kardon Model 100+ multichannel receiver encompasses the best of all forms of music reproduction. It may be installed as a stereophonic receiver capable of delivering clean, articulate sound at moderate power levels, or as a quadriphonic receiver that can fill your listening room with spacious, three dimensional sound.

When you listen to your new Harman/Kardon multichannel receiver you will instantly recognize that something truly phenomenal is taking place. The sound, which normally emerges from the speaker boxes, will lose its boundaries and will emanate from all over the room recreating the scope, depth and breadth of the concert hall. The walls of your listening room will seem to disappear and you will find yourself surrounded by a sound field that has the same ambience and spaciousness which marks a live performance. Stereophonic balance and perspective will be retained, but now there will be the addition of depth which will project you into the middle of the hall. Applause, for example, will emerge from the front, sides and rear. And during playback

of a live concert don't be too startled if you hear someone coughing or rustling his program from behind you.

The 4-Channel medium is even more dramatic for contemporary music, especially if the music was originally written for four channel reproduction. Sounds bounce back and forth from the corners of the room involving you completely with the performance. It's a new and exhilarating kind of sound that will make listening to music a new experience.

The Model 100+ bears the heritage of the Harman/Kardon trademark—ultrawideband frequency response, virtually unmeasurable distortion and all of the required conveniences so essential for the ultimate enjoyment of high fidelity reproduction.

We urge you to read this manual carefully prior to installing and operating your receiver. The Model 100+ is not a complicated instrument. However, there are certain aspects of its operation which should be understood clearly before you install and operate it.

Happy listening!

WARRANTY and SERVICE POLICY

POLICY

We warrant this receiver to be free from defects in material and workmanship under normal use and service, and in accordance with the conditions set forth below. Should a defect occur within the period specified, and provided that the unit is returned to either HARMAN/KARDON or an authorized HARMAN/KARDON warranty station, transportation prepaid, and which our examination shall disclose to our satisfaction to be defective, we will, for a period of two (2) years from date of purchase, either replace or repair and install any defective parts of the receiver free of charge.

EXCEPTIONS

This warranty does not include any obligation as to:

- a) repair or replacement of the accessory wooden enclosure due to damage incurred after initial delivery.
- b) transportation charges to and from the factory or an authorized warranty station.

REGISTRATION:

To obtain service under the terms of this policy, it is necessary for you to retain your ORIGINAL BILL of SALE. The enclosed registration card will NOT be considered proof of purchase.

In the event your equipment requires service during the warranty period, only presentation of your original bill of sale to either a factory-authorized repair agency or the factory, itself, will insure your rights under the policy, as outlined in this manual.

This warranty is not applicable to any instrument which shall have been repaired or altered in any way so as, in our judgment, to affect its stability or reliability or has been subject to neglect, misuse, negligence, or accident; or which has had the serial number altered, effaced or removed. Neither shall this warranty apply to any instrument which has been connected other than in accordance with instructions furnished by us.

SERVICE

HARMAN/KARDON has a special customer service division to answer all questions pertinent to the installation and operation of your unit. Please feel free to write to us at any time and we shall endeavor to offer prompt and complete advice.

If your problem cannot be resolved through our combined efforts, we may wish to refer you to a local authorized repair agency or we may prefer to authorize the return of your unit to the factory. In the event it must be returned, an authorization form and proper packing instructions will be forwarded to you. This authorization form **MUST BE RETURNED** with your unit.

UNDER NO CIRCUMSTANCES SHOULD YOUR UNIT BE SHIPPED TO THE FACTORY WITHOUT PRIOR AUTHORIZATION.

This warranty is in lieu of all other warranties, expressed or implied, and of all other obligations or liabilities on our part, and we neither assume nor authorize any representative or other person to assume for us any other liability in connection with the sale of this instrument.

INSTALLATION

VENTILATION

Although your new receiver rarely develops high heat, it is recommended that you leave the back of the cabinet open. If this is not possible, provide several large holes or slots as low and as high up in the cabinet back as possible. As an alternative, holes may be provided in the sides, bottom or top of the cabinet. Remember that really effective ventilation requires provision for cool air to enter at the bottom and hot air to leave at the top. A minimum clearance of two (2) inches should be allowed on each side and in the rear, between the chassis and the cabinet, and three (3) inches are required above it.

Isolate any accessories which might interfere with ventilation. For example, do not drape plastic or rubber covered interconnecting cables over the equipment.

POWER REQUIREMENTS

Connect the AC line cord to any outlet furnishing 117 volts, 60 Hz AC current. The voltage may vary between 105 and 125 volts. Two auxiliary AC power outlets are provided on the rear panel of your receiver, one being live at all times (unswitched) and the other being live only when the power switch is on (switched). Any accessory equipment (tape recorder, phonograph record player, etc.) may be connected to these receptacles. Only those connected to the switched receptacle will be controlled by the POWER switch on the front panel.

FUSING

A fuse is a safety device used to protect the receiver against possible damage due to overload or short circuits. The 100+ receiver employs five protective fuses. All five are located on the rear panel.

The AC fuse labeled 4A-3AG is used to protect the power supply of the entire system. The other four fuses labeled 4A-3AG LEFT, RIGHT, FRONT and BACK, protect the output stages of the receiver.

The output of your receiver has been designed to operate with a MAXIMUM of 5.0 amperes of current in each channel. Under certain conditions, it is possible to draw more than 5.0 amperes through the output stage which would, in turn, blow the speaker fuses. This could be caused by using multiple speaker systems where the total impedance falls below 4 ohms. (See SPEAKER IMPEDANCE).

In the event of fuse failure, replace ONLY with the same fuse type used. NEVER replace with a fuse of a higher rating. To do so will NOT protect your receiver and could result in severe damage to it which will not be covered under the warranty policy.

SPEAKER PLACEMENT (See Fig. 1)

The speakers will be referred to as LEFT and RIGHT, FRONT and BACK. Placement of the back speakers will vary with your room size, seating arrangement and acoustics. At times, it may be advantageous to place the back

speakers in line with the listener, either aiming them at the listener, the rear of the room or against the side wall. It has been acknowledged that omnidirectional speakers (i.e. Harman/Kardon HK50) serve well as back speakers in a 4-CH setup because they do not beam the sound at the listener. This gives the illusion of far greater airiness and comes closer to the sound at a live concert. We have illustrated several ways of arranging the back speakers. Some experimentation may be required before you obtain optimum sound dispersion and total surround sound. If you listen predominantly to classical music it is recommended to reflect the back speakers off the walls, or aim them away from the listener. This will tend to soften the sound and create a more natural ambience. If you listen predominantly to contemporary music it may be advantageous to place the back speakers in the corners and beam them into the room.

CONNECTING THE SPEAKERS

Use any type of wire to connect your speakers to your receiver. However, it should be pointed out that the heavier the wire, the lower the loss of power. Ordinary lamp cord, or zip cord as it is sometimes called, is excellent for this application since it can be dressed easily around the molding and it is usually heavy enough to extend great lengths without an appreciable loss in power. Do not drive tacks or staples through the center of the wire since this can result in a short circuit which would either cut the volume level down considerably or short out the sound completely. It is permissible to use approximately 50-60 feet of heavy gauge speaker connecting wire for each speaker without loss of volume.

CONNECT YOUR SPEAKERS WITH CARE, AVOID SHORTS. DO NOT CONNECT THE SPEAKERS WITH THE POWER ON. WORK CAREFULLY TRIMMING ALL LOOSE WIRES ON THE REAR OF THE SPEAKERS AND RECEIVER. THE RECEIVER HAS BEEN DESIGNED TO PREVENT DAMAGE FROM MOMENTARY ACCIDENTAL SHORTING. HOWEVER, REPETITIVE SHORTING CAN DAMAGE THE OUTPUT DEVICES.

The 100+ has provisions for two pairs of speaker systems for the front channels, and another two pairs for the back. Any pair may be driven independently or a combination of two pairs may be driven, as selected by the MAIN and REMOTE Speaker Switches. Connect them to the receiver as instructed in the diagrams (Fig. 2 and Fig. 3), taking care not to confuse the FRONT and BACK, LEFT and RIGHT channels, and the plus and minus polarities. Sufficient care should be taken not to short circuit the plus and minus leads.

SPEAKER IMPEDANCE

Each speaker system connected to your 100+ must possess an impedance of from 4 to 16 ohms. Should you wish to drive two pairs of speaker systems simultaneously, they should all have an impedance of 8 ohms or more.

It should be noted that it is not necessary to match the impedance of the speakers to the receiver since the 100+ is a solid state instrument and can accommodate all speakers ranging in impedance from 4 to 16 ohms without special transformers.

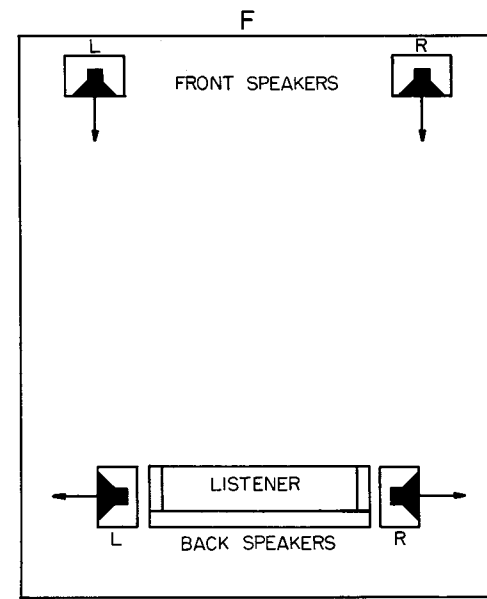
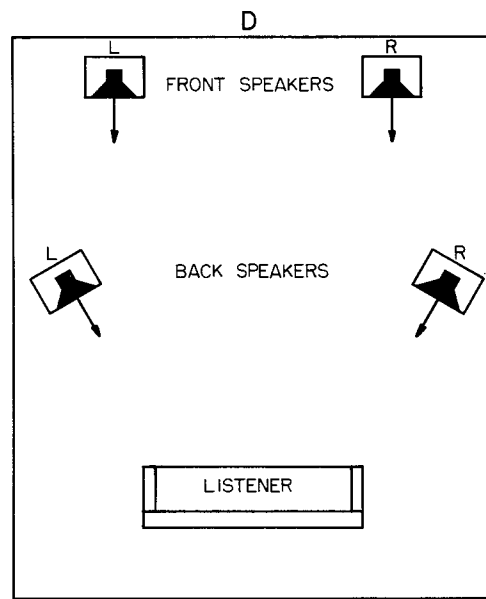
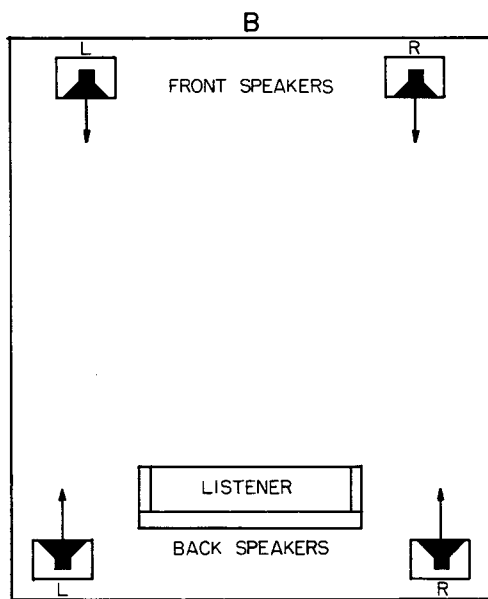
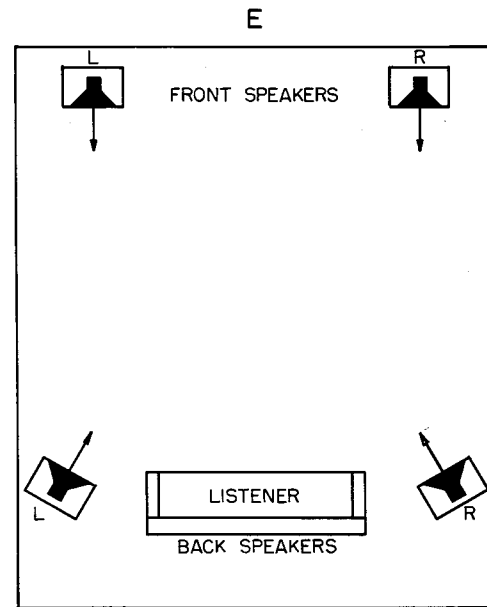
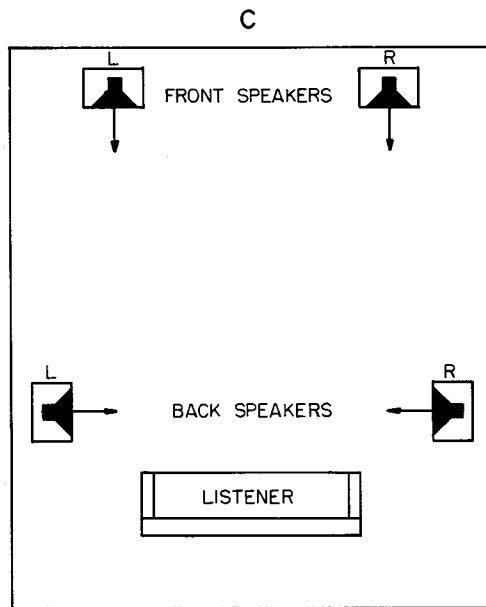
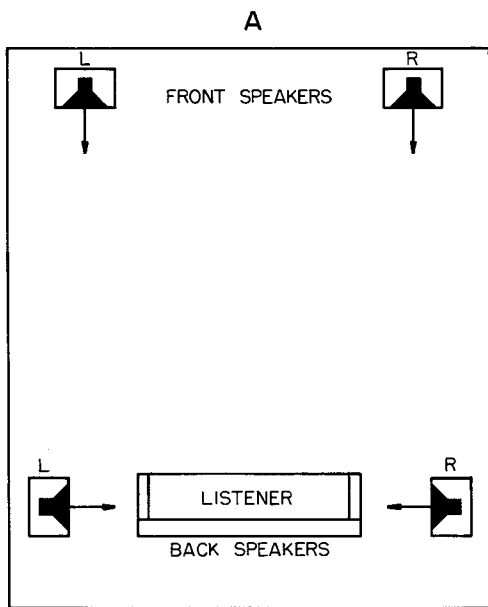

FIG 1

QUADRIPHONIC OPERATION (See Fig. 2)

Refer to the introductory comments under the heading CONNECTING THE SPEAKERS.

1. Connect one length of lamp cord to the LEFT FRONT speaker.
2. Attach the other end of the lamp cord to the MAIN, FRONT screw terminals marked LEFT + and - on the rear panel of your receiver.
3. Similarly connect another length of lamp cord to your RIGHT FRONT speaker.
4. Attach the other end of the lamp cord to the MAIN, FRONT terminals marked RIGHT + and - on the rear panel of your receiver.
5. Connect a length of lamp cord to your LEFT BACK speaker.
6. Attach the other end of the lamp cord to the MAIN, BACK terminals marked LEFT + and - on the rear panel of your receiver.
7. Connect another length of lamp cord to your RIGHT BACK speaker.
8. Attach the other end of the lamp cord to the MAIN, BACK terminals marked RIGHT + and - on the rear panel of your receiver.
9. Repeat above steps to connect REMOTE speakers.

NOTE: BE CERTAIN THAT THE STEREO/4-CH SWITCH LOCATED ON THE REAR PANEL OF THE RECEIVER IS SET IN THE 4-CH POSITION.

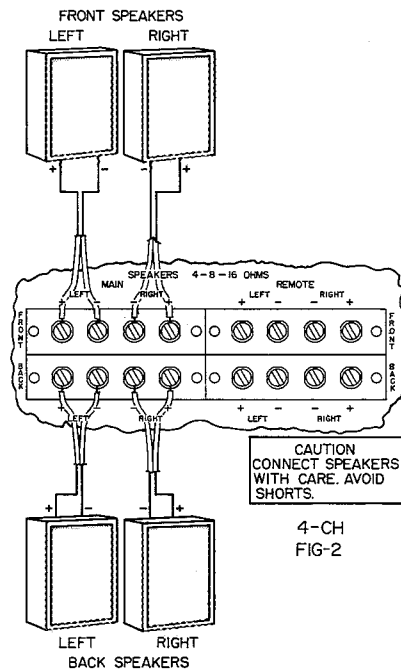

STEREO OPERATION (See Fig. 3)

Refer to the introductory comments under the heading CONNECTING THE SPEAKERS.

1. Connect one length of lamp cord to the LEFT FRONT speaker.
2. Attach the other end of the lamp cord to the MAIN, FRONT terminals marked LEFT + and - on the rear panel of your receiver.
3. Similarly connect another length of lamp cord to your RIGHT FRONT speaker.
4. Attach the other end of the lamp cord to the MAIN, FRONT terminals marked RIGHT + and - on the rear panel of your receiver.
5. Repeat above steps to connect REMOTE speakers.

NOTE: BE CERTAIN THAT THE STEREO/4-CH SWITCH LOCATED ON THE REAR PANEL OF THE RECEIVER IS SET IN THE STEREO POSITION FOR DOUBLE POWER STEREO OPERATION.

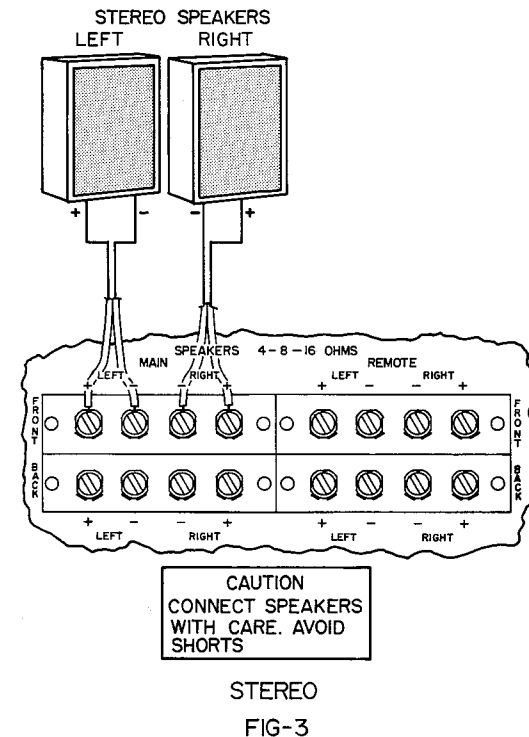

SPEAKER PHASING

For maximum enjoyment of multichannel sound, it is important to have the four speaker systems in phase. The phase relationship must be correct, not only between the front left and right speaker systems, the back left and right speaker systems, but also between the front and back channels.

When connecting each speaker system to the receiver, be certain to maintain plus and minus polarities.

If your speakers do not have a plus/minus polarity identification, phasing can be accomplished by the following procedure:

1. After connecting your speakers, place the receiver in the MONO mode of operation and the SOUND FIELD BALANCE control to the exact top center position.

2. Play a record, tape or FM broadcast which has a single speaking or singing voice, or a solo instrument.
3. The voice or instrument should appear to be emerging from an area somewhere in the center of the two speakers. If the voice seems to come from both speakers independently, the speakers are out of phase.
4. If you determine that your speakers are out of phase, merely disconnect the leads from only one of the speakers and reverse them. Your stereo system will now be in phase.

This completes the phasing of a pair of speakers for stereo operation.

Repeat this process for all additional pairs of speakers in your system.

OPERATING PROCEDURE

Every control on this receiver serves a specific and useful function and is important for the proper operation of your stereo or 4-Channel system. Read this section carefully so you can take full advantage of all the performance capabilities of this receiver.

SWITCH — REAR PANEL STEREO/4-CH SWITCH

The 100+ receiver is shipped with the STEREO/4-CH switch in the 4-CH mode. A special safety latch is fitted next to the switch to prevent throwing the switch accidentally while the receiver is turned on.

If you plan to use the 100+ as a DOUBLE-POWER STEREO receiver, first turn off the unit, remove the safety latch and throw the STEREO/4-CH switch to STEREO. NOTE: After changing position of this switch ALWAYS replace the safety latch.

The two front channels now have the capability of delivering double power to your speakers.

NOTE: WHEN THE STEREO/4-CH SWITCH IS IN THE STEREO POSITION THE BACK SPEAKERS ARE INOPERATIVE. IF YOU WISH TO USE THE RECEIVER TO POWER ANY BACK SPEAKERS, FIRST TURN OFF THE RECEIVER. REMOVE THE LATCH AND THROW THE STEREO/4-CH SWITCH TO 4-CH. REPLACE THE PROTECTIVE LATCH.

SWITCHES — BOTTOM PANEL MUTING ADJUSTMENT CONTROL

This bottom panel control adjusts the level at which muting action will take place. Minimum muting action occurs in the full counterclockwise position. Maximum muting is achieved in the full clockwise position.

The full clockwise position will also eliminate stations with poor transmission quality. The control should be adjusted to the point where you receive only those stations which meet your standards of broadcast quality.

STEREO THRESHOLD CONTROL

This control can be adjusted to determine the number of stereo stations the tuner will reproduce in the STEREO FM position of the Function Switch.

In the full counterclockwise position, the automatic switching circuits have maximum sensitivity and all stereo stations within the range of the tuner will be reproduced. However, due to weak signals (or their distance from your antenna) some stations will contain noise levels which degrade performance when reproduced in stereo. In order to reproduce these stations monophonically (when in the STEREO FM position of the Function Switch), rotate the STEREO THRESHOLD control clockwise until only good quality stereo stations are reproduced.

SWITCHES AND CONTROLS — FRONT PANEL POWER SWITCH

The POWER switch performs the function as its name denotes. It supplies power to the receiver. When the pushbutton is depressed to turn the set ON the power light will illuminate.

HEADPHONE JACKS

The stereo or 4-CH headphone receptacles located on the front panel of your 100+ receiver will accept any type of headphone. Stereo phones come with a single plug which should be connected to the FRONT receptacle. 4-CH phones come with two plugs. Connect the front plug to the FRONT receptacle and the back plug to the BACK receptacle. The headphone receptacles are "ON" at all times. To listen only to your phones without having your speakers on, merely set the SPEAKER switches on the front row of pushbuttons to "OFF".

MAIN SPEAKER SWITCH

In order to hear the speakers connected to your main system, the respective FRONT and BACK MAIN speaker switches must be depressed.

When in the "ON" position the speakers connected to the main system are "ON". Should you desire to listen to stereo or 4-CH headphones alone, the speakers can be turned off at your discretion.

REMOTE SPEAKER SWITCH

In order to hear all of the speakers connected to your remote system, the respective FRONT and BACK REMOTE speaker switches must be depressed.

When in the "ON" position the speakers connected to the remote system are "ON". Should you desire to listen to stereo or 4-CH headphones alone, the speakers can be turned off at your discretion.

EXT DOLBY NR/TAPE MON 2 SWITCH

When an FM station broadcasts a Dolby encoded program, it may be decoded by use of an external Dolby processor. If you use an external processor, the Dolby switch when depressed, will decode an encoded program. If the Dolby button is depressed without an external processor connected, you will get zero output from your speaker system.

Dolby IN receptacles may be used as a 2-channel Tape Monitor provided you are not using the Dolby Function.

TAPE MON 1 SWITCH

If your 4-CH tape recorder has a special monitoring feature, depressing this switch "IN" will permit you to monitor your tapes a split second after they are recorded. When not in use this switch must be in the "OUT" position, otherwise it will defeat the output of the receiver.

This switch and associated rear panel receptacles can also be used as an additional set of stereo or 4-CH high level inputs.

CONTOUR SWITCH

One of the limitations of human hearing is its tendency to lose sensitivity to the very low pitched sounds as the program sound level is reduced. It is this characteristic (known as the Fletcher-Munson effect) which causes one to play music programs at high listening levels in order to experience the full rich tone available from fine modern recordings.

The Harman/Kardon CONTOUR switch compensates for this effect, thereby eliminating high listening levels as a requisite for full enjoyment of reproduced music. For warm, full-bodied reproduction at low listening levels, throw the CONTOUR switch to the IN position. At high levels, the CONTOUR switch has no effect.

FM MUTING SWITCH

The purpose of the muting circuit is to reduce audible noise when tuning from station to station. Since very weak signals may be muted at the same time, the front panel FM MUTING switch may be used to defeat the muting circuit on weak signals.

To reduce interstation noise, push the MUTING switch "ON". To defeat the circuit, push the switch "OFF".

To adjust muting levels see MUTING ADJUSTMENT CONTROL.

HIGH CUT SWITCH

The HIGH CUT filter has been designed to reduce the high frequency response of your receiver. This will reduce annoying record scratch, tape hiss, FM background noise, etc.

LOW CUT SWITCH

At times, record changers, turntables and even some FM stations produce an objectionable low frequency signal that is strong enough to be introduced into the playback system. This is known as rumble and can be cancelled out by the special low frequency cut off filter network included in this receiver. Whenever rumble is present depress the LOW CUT switch.

FUNCTION SWITCH

This switch selects the desired program source to be heard through your music system.

PHONO 1/PHONO 2

Use these positions for all mono, stereo or SQ matrix records.

Any standard stereo record player can play SQ matrix discs without special modifications. The SQ disc is completely compatible with stereo systems and can be played on any quality record changer or manual turntable using a high compliance magnetic pickup.

Your existing record player connected to the LEFT and RIGHT, PHONO 1 or PHONO 2 input receptacles will play your mono, stereo and SQ records. In order to play SQ discs in 4-CH the mode switch should be placed in either the SQ matrix 1 or SQ matrix 2 positions.

STEREO FM

This is the normal listening position for all monophonic or stereophonic FM broadcasts. In this position the stereo indicator light and automatic switching circuit built into your receiver are operative. For further details refer to paragraph on "SELECTING MONOPHONIC OR FM STEREO BROADCAST".

Should you receive a weak stereo signal whose quality has been degraded by noise or poor signal conditions, and you wish to listen to this stereo broadcast monophonically, switch to the FM position.

FM

In this position you can listen to stereophonic broadcasts monophonically while monophonic broadcasts will appear unchanged.

DISCRETE FM/AUX

In this position, the addition of an accessory 4-CH decoder will permit the reception of discrete FM.

This position, when not being used for discrete FM, may be used as an additional 4-CH/AUX position. As soon as an FM broadcast system has been selected, Harman/Kardon will be in the position of supplying an appropriate decoder.

DISCRETE PHONO/AUX

This selects the four discrete phono/aux receptacles on the rear panel for playback through your system (tape recorder, cartridge player, discrete phono system) with appropriate decoder.

This quadriphonic system is different than the SQ matrix design and requires a special decoder between your phonograph and Harman/Kardon 100+ receiver. Your phonograph should employ a high compliance, low tip-mass phono cartridge capable of extending in frequency response to beyond 45,000 Hertz to play back the CD-4 disc. The special decoder should be connected to the LEFT and RIGHT FRONT/BACK DISCRETE PHONO/AUX receptacles located on the rear panel of the 100+. (Refer to "Connecting a Stereo Record Player with 100+ Decoder").

Harman/Kardon intends to manufacture a decoder for use with discrete systems. For additional information on this system and the availability of the Harman/Kardon discrete phono decoder, write to our Customer Service Department.

AM

This selects the AM section of your receiver.

BASS & TREBLE CONTROLS

These controls are employed to set the tonal balance of your stereo or 4-CH system. The Bass control adjusts the low frequencies, either strengthening or diminishing the intensity of these sounds. The Treble control adjusts the higher frequencies in the same manner — either strengthening or diminishing the sound.

In most instances these controls will be set to the "flat" or center position. If bass or treble adjustment is necessary, do not rotate these controls to their maximum settings. This may introduce distortion especially if your speakers cannot handle the power of the boosted sound. These controls should be used sparingly and with the knowledge that live music is neither excessively sharp or boomy.

You may adjust both the BASS and TREBLE for front and back pairs of speakers simultaneously or individually. The inner knobs adjust the front speakers and the outer knobs, the back speakers. In order to adjust both pairs, turn both inner and outer knob. In order to adjust front or back only, hold one knob while adjusting the other.

MODE SWITCH

This switch allows you to select the proper mode of operation for the various sources available.

MONO

In this position, all program sources will be reproduced in the monophonic mode.

If an external monophonic source (one channel) is used it MUST be connected to the appropriate LEFT FRONT input receptacles in order to reproduce sound in all speakers.

The **1** mode indicator light will be illuminated indicating a monophonic mode of operation.

STEREO

In this position, all stereophonic program sources will be reproduced in the STEREO mode.

All pairs of speakers connected to the FRONT terminals will reproduce stereo program material. With the STEREO/4-CH REAR PANEL SWITCH in 4-CH position, speakers connected to the BACK terminals will also reproduce stereo in each pair.

In the STEREO position, the **2** mode indicator light will be illuminated indicating a stereophonic mode of operation.

SQ MATRIX 1/2

These positions may be used to reproduce all SQ program material.

In the SQ MATRIX 1 and SQ MATRIX 2 positions the **4 2 4** mode indicator lights will be illuminated.

These lights denote the methods used from the source material to the recording, to reproduction.

The SQ MATRIX 2 position performs the same function as the SQ MATRIX 1 position except that it changes the relationship of separation between the LEFT and RIGHT and FRONT and BACK speakers.

When in this position the separation between LEFT and RIGHT will be partially reduced from that obtained in the normal SQ MATRIX 1 position and the separation between FRONT and BACK will be slightly increased.

When reproducing full orchestral material, the mode selector should be in the SQ MATRIX 1 position. When reproducing individual instruments or soloists the mode selector switch should be in the SQ MATRIX 2 position.

ENHANCED STEREO

This position should be used to enhance (convert) any stereo source into spatially expanded sound. When playing any stereo source, if your 100+ has been installed utilizing four or eight speakers, the sound will emerge from each speaker filling the room with sound that is almost as exciting as authentic 4-CH.

It may also be used to spatially enhance a monophonic source.

In this position the **2 4** mode indicator lights will be illuminated, denoting stereo to 4-CH operation.

4-CH DISCRETE

In order to utilize this position you MUST have a four channel source connected to the system.

In this position **4 4** mode indicator lights will be illuminated denoting 4-CH to 4-CH operation.

VOLUME CONTROL

THE VOLUME control adjusts the signal level of any program material connected to your receiver. It is a four section control which simultaneously adjusts all channels, and its close tracking specifications insure that the relative volume level of each channel will be identical.

SOUND FIELD BALANCE

Your 100+ incorporates a unique four channel continuously variable balance control.

The nature of stereo or 4-CH reproduction is such that it requires identical channels to attain the highest degree of faithfulness and spatial distribution. Any variation in the efficiency of any channel as compared to the others will disturb this relationship. Since there may be slight differences between program material, room acoustics, etc., your receiver includes a control to balance all channels. Sufficient range is covered by this control to permit rebalancing of the overall system even in cases where major unbalance exists. This control may be set anywhere within its range to attain system balance. It does not necessarily have to be set in the exact center position.

When the BALANCE control is properly set, the apparent sound source will lie in a broad area between all speakers.

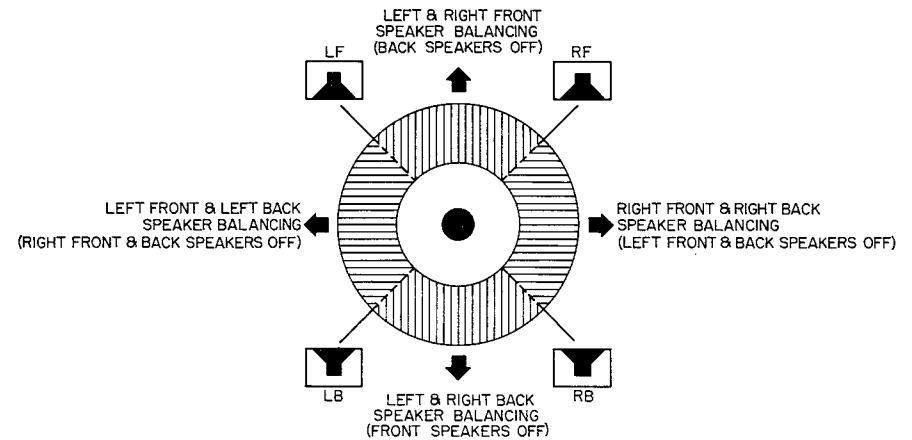

TUNING

The tuning knob, located on the right side of the receiver is used to select the desired station when your FUNCTION switch is in the FM, STEREO FM, or AM position.

SELECTING MONOPHONIC OR FM STEREO BROADCAST

Under normal use for all FM broadcasts the function selector switch should be placed in the STEREO FM position.

Your receiver is equipped with a stereo sensing circuit which will automatically determine whether your unit is receiving monophonic or stereophonic broadcasts, and then automatically adjust the mode of operation.

If the station is transmitting stereo, your receiver will automatically switch on the multiplex section and you will hear the broadcast in full stereo. Should the station conclude broadcasting in stereo, your receiver will automatically switch back to monophonic reception.

Should you receive a weak stereo signal whose quality has been degraded by noise or poor signal conditions, and you wish to listen to this stereo broadcast monophonically, place the function selector switch in the FM position.

TUNING METERS

Your Receiver incorporates two D'Arsonval movement tuning meters for precise and accurate tuning.

The FM tuning meter is designed to operate on a null or "zero" center principle. Therefore, the meter pointer should always be at the dead center position of your meter dial for optimum listening performance. To accomplish this, rotate your tuning knob slowly, in one direction towards the station of your choice. As you tune through the station you will notice the pointer swinging from the left or right past the zero center. THE CORRECT POINT for minimum distortion and optimum FM reception is when the pointer is resting at the "zero" center position.

The signal strength meter shows the level of the incoming signal. When used in the FM position you should operate in conjunction with the FM tuning meter and tune for maximum indication on the signal strength meter as well as a "zero" null on the tuning meter.

When used in the AM position you simply tune for maximum indication.

STEREO INDICATOR

A stereo indicator is located adjacent to the FM tuning meter and operates in conjunction with the STEREO FM position of the Function switch. The indicator visually shows the reproduction of FM stereo through your receiver. To tune for FM stereo proceed as follows:

1. Place the function selector switch in the STEREO FM position.
2. Tune to the station of your choice using your tuning meter for precise and accurate tuning. Your stereo indicator will now show if you are tuned to a stereo program. If the indicator is off, the program you are listening to is being broadcast monophonically.

DIAL SCALE

The dial scale on your receiver is marked with three scales, namely, an FM frequency scale (88-108 MHz), a logging scale (0-10), and an AM frequency scale.

Since most FM stations operate at frequencies which are not whole numbers (such as 96 MHz as compared to 96.3 MHz), ideally, each megahertz division on the frequency scale should be divided into 10 parts to enable the user to pinpoint the location of the station. This would require a dial scale which would be longer than the front panel.

The logging scale which is divided into 100 equal parts provides a means of finding your favorite station, once you have noted its position on the logging scale. For example, in New York City, WQXR operates at 96.3 MHz. After locating this station through the use of the frequency scale (between 96 and 98 MHz), you find that the pointer may fall on 4.2 on the logging scale. Make a note of this setting. For future tuning to WQXR simply set the pointer to 4.2 on the logging scale.

EQUALIZATION

In order to achieve good reproduction of the wide range of frequencies in music and to make necessary adjustment for the limitations of the recording technique, record manufacturers have found it necessary to modify the actual frequency response of the music while it is being recorded. Thus, to avoid overcutting and consequent distortion, a measured and deliberate reduction is effected in low frequency response by selecting a "turnover frequency" and recording attenuated response below that point. To assure optimum signal to noise at the high frequency end when the record is played at home, the highs are deliberately exaggerated during the recording process. A measured and deliberate boost is affected above a certain frequency. This combination of deliberate exaggeration at the low and high ends of the frequency spectrum can be expressed in a recording curve. When the record is played a mirror image of that curve should be available so that the ideal "flat" response may be achieved.

The PHONO 1/PHONO 2 positions of the function switch automatically introduces the proper equalization.

HUM AND NOISE

In any high fidelity installation, hum may be caused by the interconnection of a record player, tuner and amplifier, as a result of the cables and different grounds. If hum is experienced with your receiver, disconnect everything but the speakers from the receiver. If hum persists, reverse the AC line cord. Plug in the record player and if hum appears, reverse the record player power plug and connect a single lead from the record player chassis to the ground post on the rear of the receiver chassis. Connect your other devices in this manner. CAUTION: Hum may also be induced by defective connecting cables or by running these cables too close to a strong AC field.

FRONT PANEL

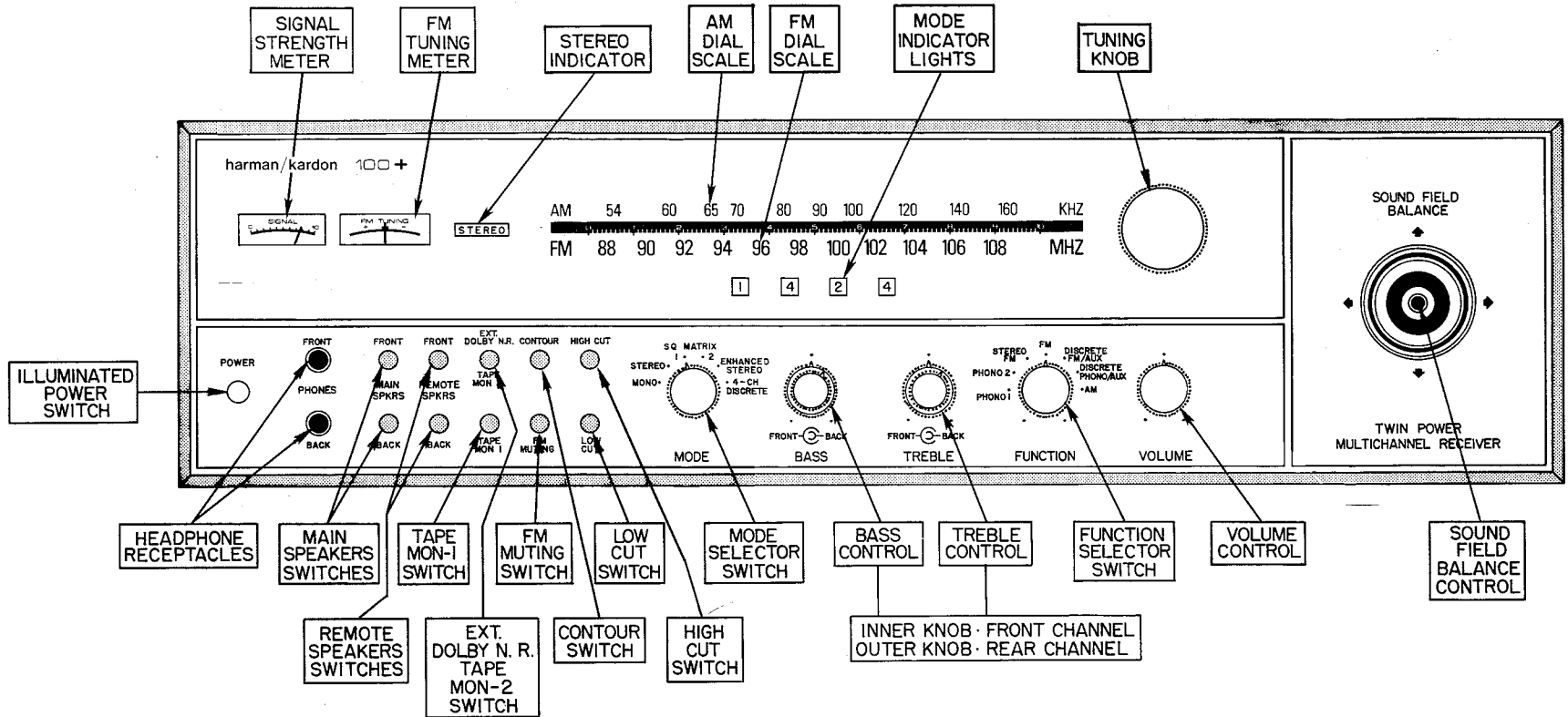

REAR PANEL

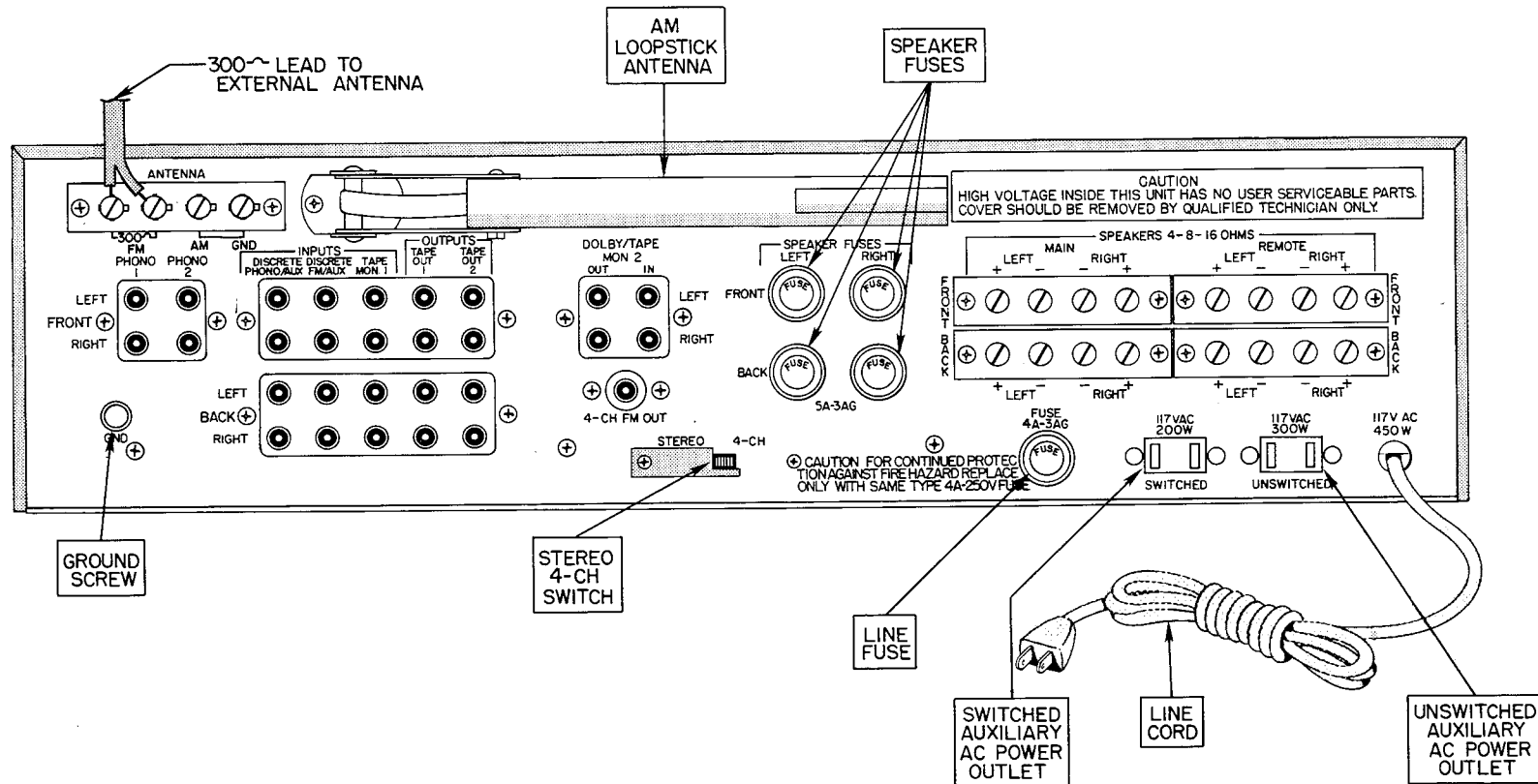

TYPICAL APPLICATIONS

The following drawings show connections of various types of accessory equipment. With each drawing a "typical" application is described.

Refer to paragraph "MODE SWITCH" for information and explanation.

CONNECTING A MONO RECORD PLAYER

Typical Operating Conditions

Function Switch: Set to PHONO 1 position
 Mode Switch: Set to MONO position

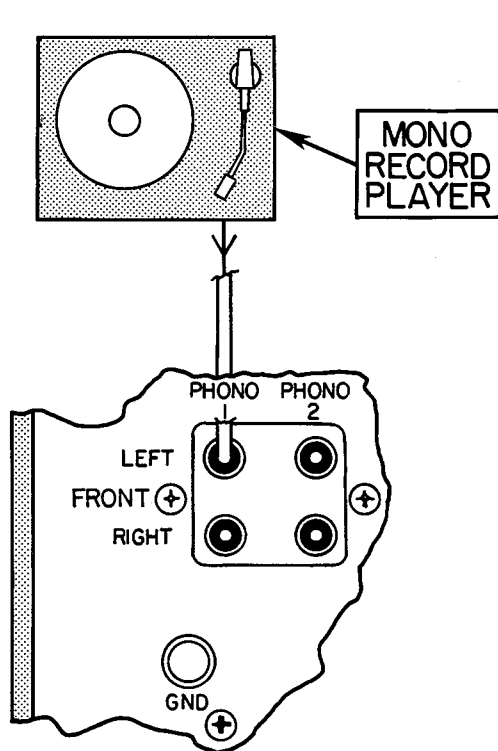

CONNECTING ONE OR TWO STEREO RECORD PLAYERS

Typical Operating Conditions (Stereo Record)

Function Switch: Set to PHONO 1 or PHONO 2 position
 Mode Switch: Set to STEREO position

Typical Operating Conditions (SQ Record)

Function Switch: Set to PHONO 1 or PHONO 2 position
 Mode Switch: Set to SQ MATRIX 1 or SQ MATRIX 2 position

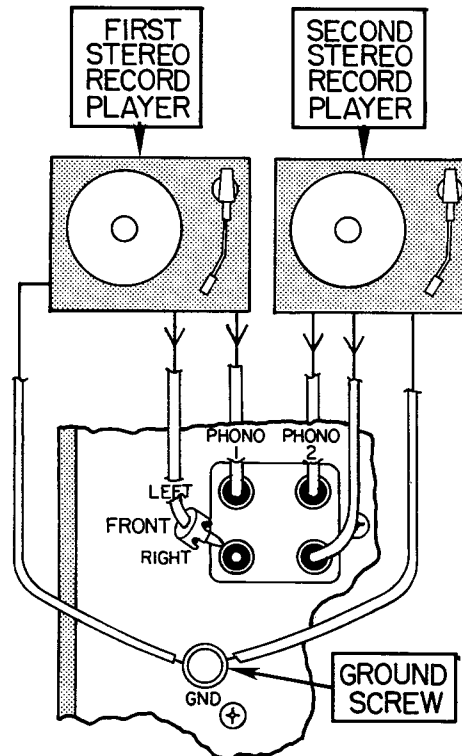

CONNECTING A STEREO RECORD PLAYER WITH DECODER

Typical Operating Conditions

Function Switch: Set to DISCRETE PHONO/AUX position
 Mode Switch: Set to 4-CH DISCRETE position

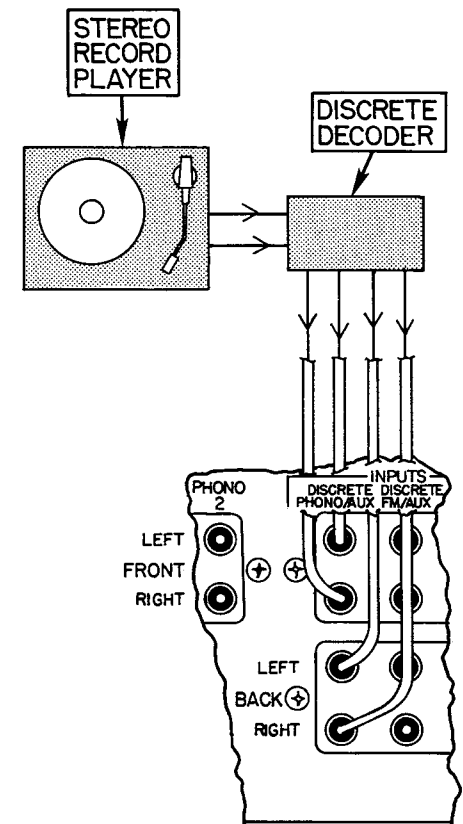

CONNECTING A STEREO TAPE RECORDER

Typical Operating Conditions

To Record

Function Switch: Set to source desired

To Playback/Monitor

Tape Mon 1 Switch: Set to "IN" position
 Mode Switch: Set to STEREO position

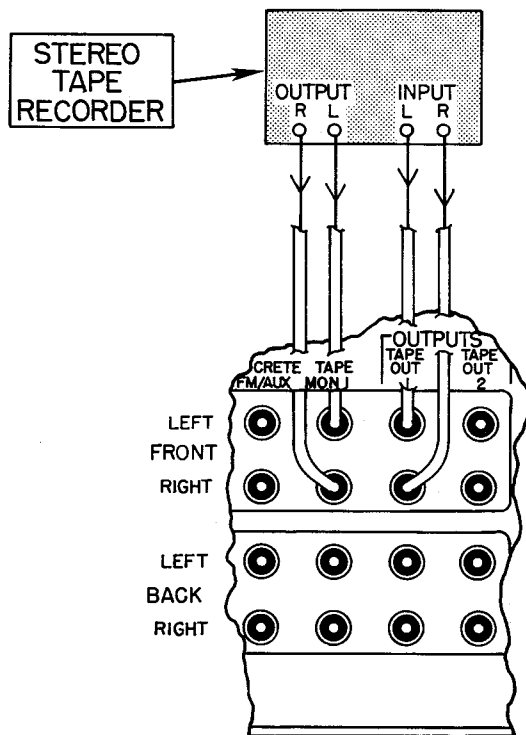

CONNECTING A 4-CHANNEL TAPE RECORDER

Typical Operating Conditions

To Record

Function Switch: Set to source desired

To Playback/Monitor

Tape Mon 1 Switch: Set to "IN" position
 Mode Switch: Set to 4-CH DISCRETE position

NOTE: In order to make a 4-CH recording, it is necessary to have a 4 channel source connected to the recorder.

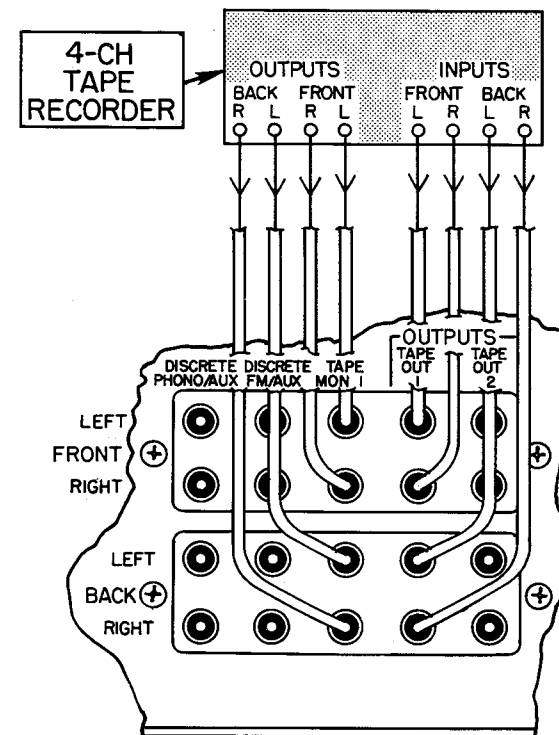

CONNECTING TWO STEREO TAPE RECORDERS

Typical Operating Conditions

To Record on Tape Recorder #1

Function Switch: Set to source desired

To Playback/Monitor from Tape Recorder #1

Tape Mon 1 Switch: Set to "IN" position

Mode Switch: Set to STEREO position

To Record on Tape Recorder #2

Function Switch: Set to source desired

To Playback/Monitor from Tape Recorder #2

Tape Mon 2 Switch: Set to "IN" position

Mode Switch: Set to STEREO position

To Record from Tape Recorder #1 to Tape Recorder #2

Tape Mon 1 Switch: Set to "IN" position

NOTE: When using two tape recorders, attached as shown, TAPE MON 2 will take precedence over TAPE MON 1

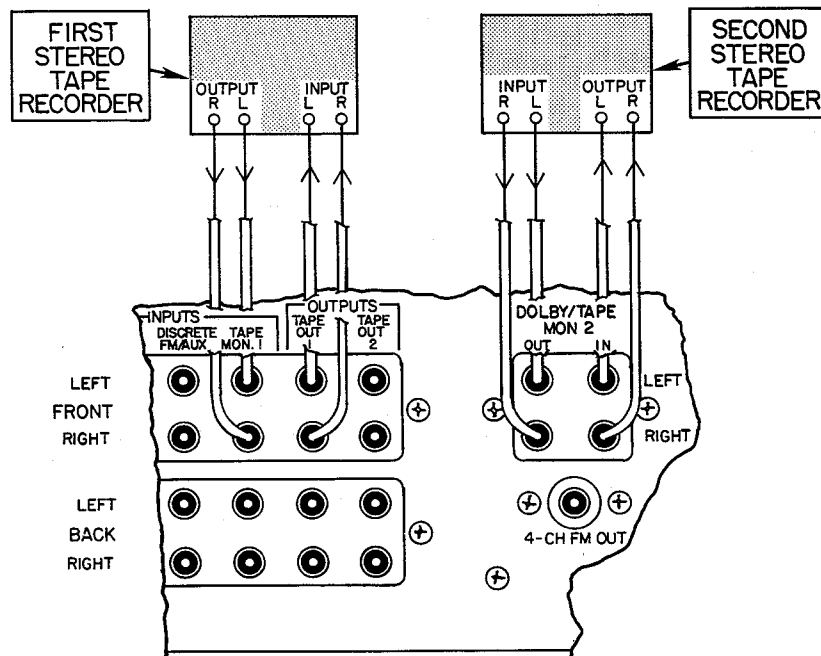

CONNECTING TWO 4-CHANNEL TAPE RECORDERS

Typical Operating Conditions

To Record on Tape Recorder #1

Function Switch: Set to source desired

To Playback/Monitor from Tape Recorder #1

Tape Mon 1 Switch: Set to "IN" position

Mode Switch: Set to 4-CH DISCRETE position

To Record on Tape Recorder #2

Function Switch: Set to source desired

To Playback from Tape Recorder #2

Function Switch: Set to DISCRETE PHONO/AUX position

Mode Switch: Set to 4-CH DISCRETE position

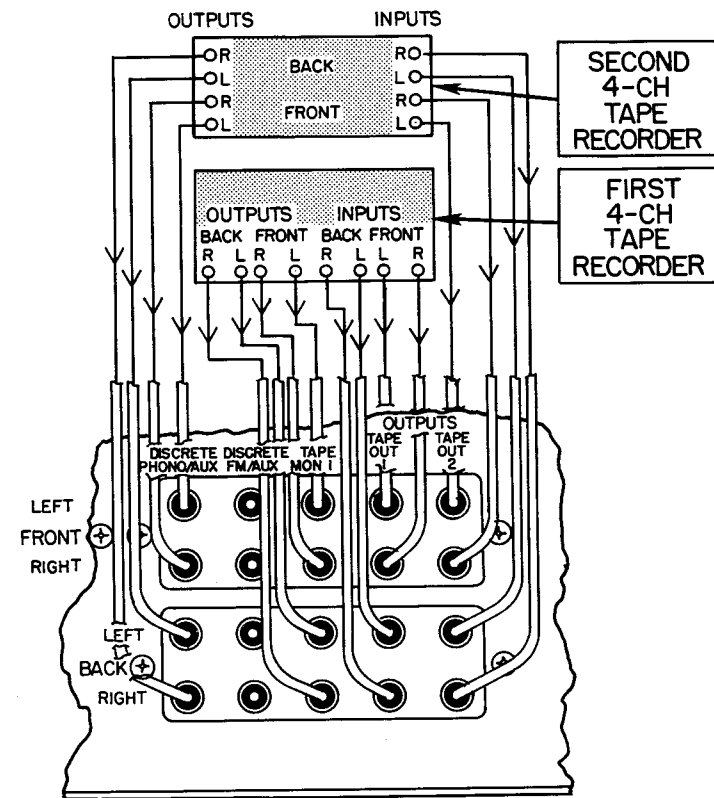

TO CONNECT EXTERNAL DOLBY NR

To Operate

- Function Switch: Set to source desired
- Ext Dolby NR Switch: Set to "IN" position
- Mode Switch: Set to STEREO position

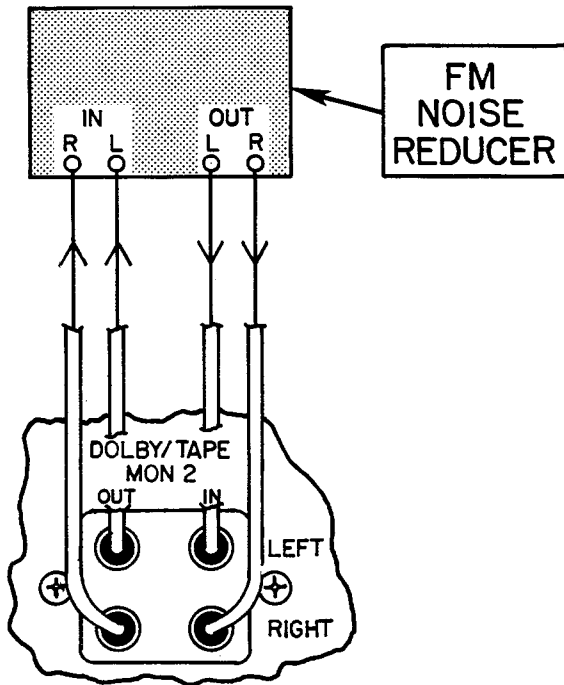

TO CONNECT FOR DISCRETE FM

To Operate

- Function Switch: Set to DISCRETE FM/AUX position
- Mode Switch: Set to 4-CH DISCRETE position

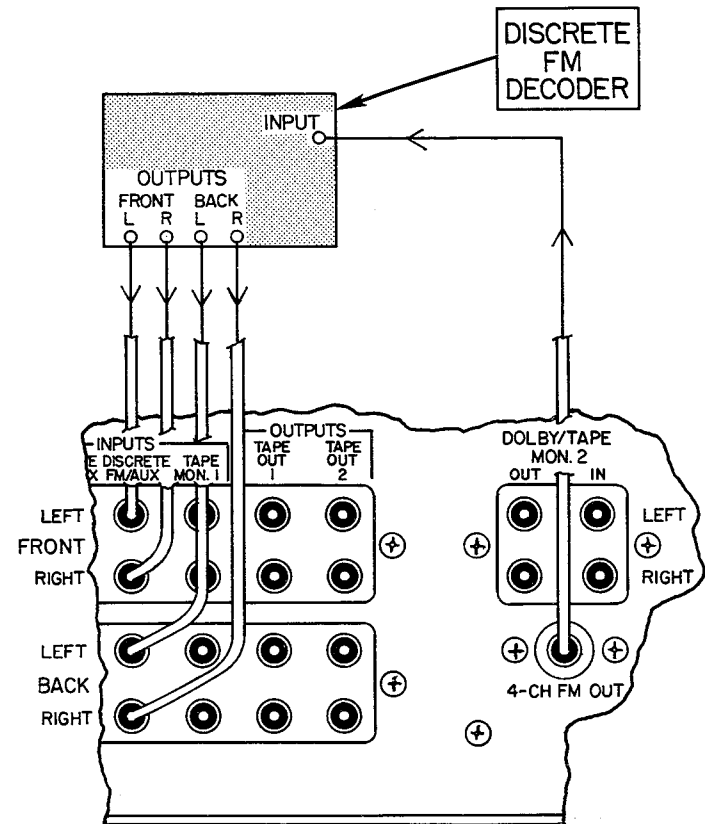

SPECIAL APPLICATION

The versatility of the 100+ receiver permits the utilization of 2 completely separate stereo systems reproducing different program material.

Typical Example

System #1 — Connect left and right speakers to the front left and right speaker terminals.

System #2 — Connect left and right speakers to the back left and right speaker terminals.

Connect a pair of patch cords from the front tape out receptacles to the front tape monitor receptacles.

Connect a stereo tape recorder output to the back tape monitor receptacles.

Mode switch to 4-CH Discrete position.

With the tape monitor 1 switch depressed, System #1 will reproduce any source selected by the function switch. System #2 will reproduce the output of the tape recorder.

The volume control should be used to set the overall level.

The sound field Balance control should be used to alter the levels of the separate systems.

The front and back Tone controls will function separately for each system.

The Stereo 4-CH rear panel switch must be in the 4-CH position.

SERVICE

If this instrument should not perform properly during the first two (2) years after date of purchase, contact the factory for instructions. The factory has many authorized warranty service stations in the United States. To aid us in selecting a service station convenient to you, it would be helpful if you would indicate which major city is closest to your home. Please write our Customer Service Department, Harman/Kardon, Incorporated, Plainview, New York 11803. Be sure to include the model and serial number of the unit. A brief description of your other components is often of help in answering your questions. DO NOT return this instrument to Harman/Kardon without first receiving authorization.

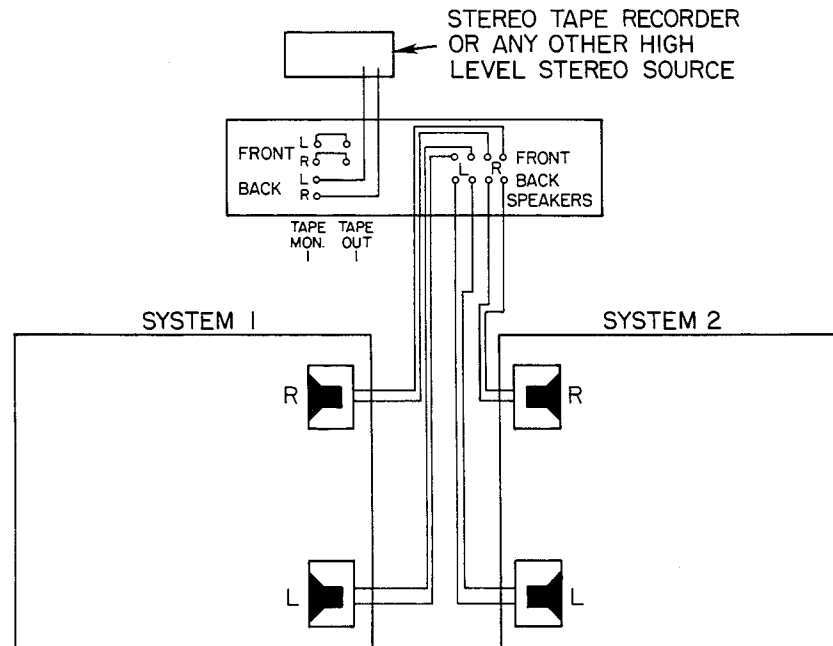

SPECIFICATIONS

AMPLIFIER SECTION

- Power Output:** 57.5/57.5 watts, RMS, both channels driven simultaneously into 8 ohms, 20-20kHz at less than 0.5% THD at 120 volts, 50/60 Hertz AC. (In special double power stereo mode)
4x 24 watts, RMS into 8 ohms, 20-20kHz at less than 0.5% THD at 120 volts, 50/60 Hertz AC. ALL FOUR CHANNELS DRIVEN SIMULTANEOUSLY.
(Power measurements made by the most stringent and conservative standards. If measured by competitive standards, power would be 68/68 in stereo and 4x 35 in 4-CH)
- Power Bandwidth:** From less than 10 to beyond 40kHz into 8 ohms, all channels driven in stereo or 4-CH mode at less than 0.5% THD.
- Total Harmonic Distortion:** Less than 0.5% at any power rating from 0.1 watt to full rated power. (Typically runs below 0.2% from 20-20kHz at full power output)
- Intermodulation Distortion:** Less than 0.15% at rated output.
- Hum and Noise:** Better than 85dB below rated output (unweighted) in stereo or 4-CH mode.
- Damping Factor:** 40:1 at 4 and 8 ohms.
- Frequency Response:** From below 4 Hertz to beyond 70kHz, ± 0.5 dB at normal power levels.
From below 1 Hertz to beyond 100kHz ± 1.0 dB at normal power levels.
- Square Wave Tilt:** Less than 10% at 20 Hertz.
- Square Wave Rise Time:** Better than 2 microseconds.
- Stability:** Absolutely stable with any type load.
- Phono Overload:** Greater than 75+ millivolts.
- Bass and Treble Tone** ± 12 dB bass boost and cut at 50 Hertz.
Control Action: ± 12 dB treble boost and cut at 10kHz.

TUNER SECTION

- FM Sensitivity:** 1.9 microvolts, IHF.
- Ultimate Signal to Noise Ratio:** 70dB.
- Capture Ratio:** 2.2dB.
- Image Rejection:** -50dB.
- Spurious Response Rejection:** -80dB.
- Multiplex Separation:** 35dB at 1 kHz.
- Total Harmonic Distortion:** 0.5% MONO
0.6% STEREO
- AM Rejection:** -55dB.
- SCA Suppression:** Totally inaudible.
- AM Sensitivity:** 200 microvolts/meter.
- Image Frequency Rejection:** Better than 55dB.
- IF Rejection:** Better than 55dB.
- Selectivity:** Better than 34dB.

GENERAL

- Dimensions:** 18 $\frac{3}{4}$ " W x 15 $\frac{1}{4}$ " D x 5" H (less knobs)